

TOP

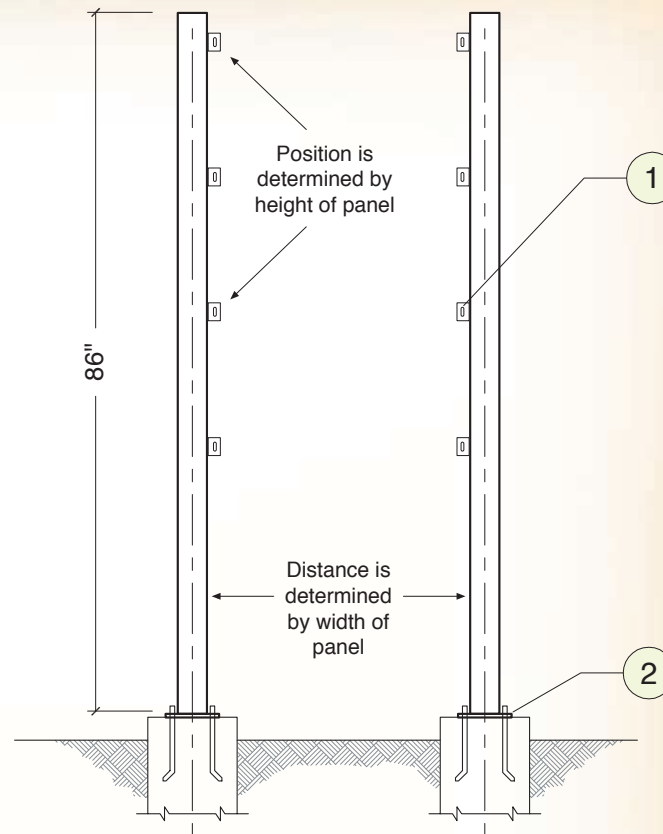

FRONT

## TRIANGULAR KIOSK

Part #: KIOSK-86

\*\* Custom sizes available upon request

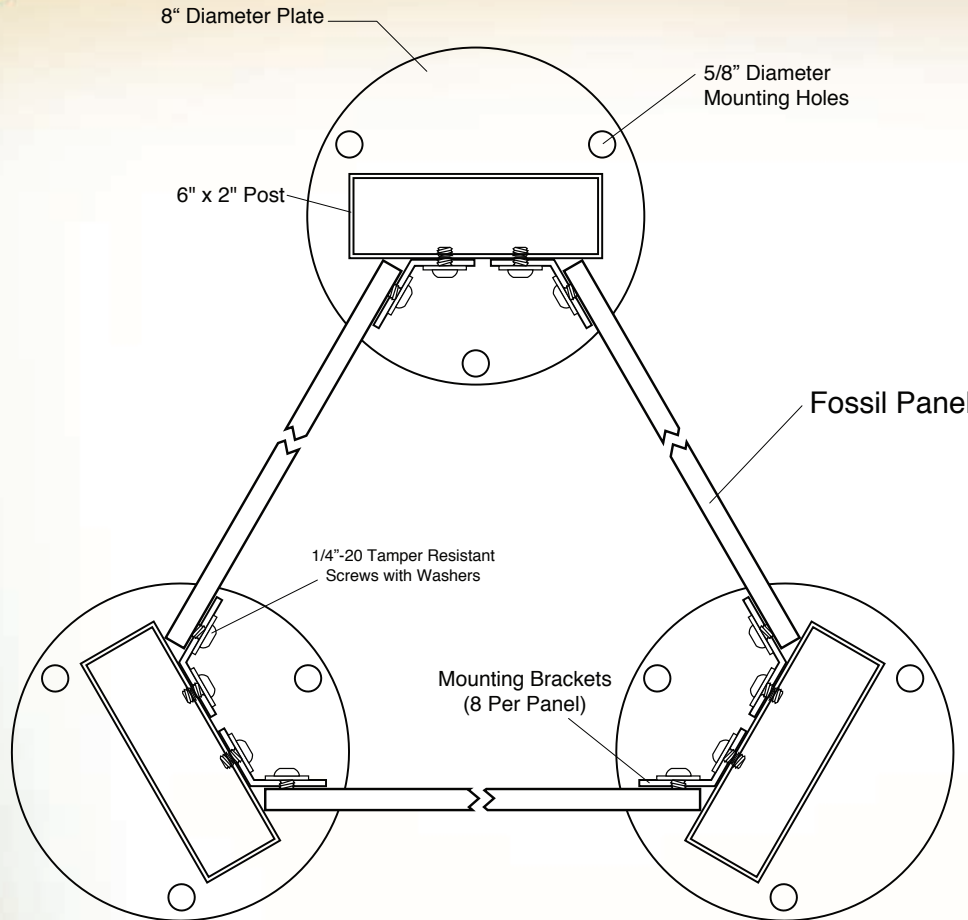

Triangular Kiosk - Top View

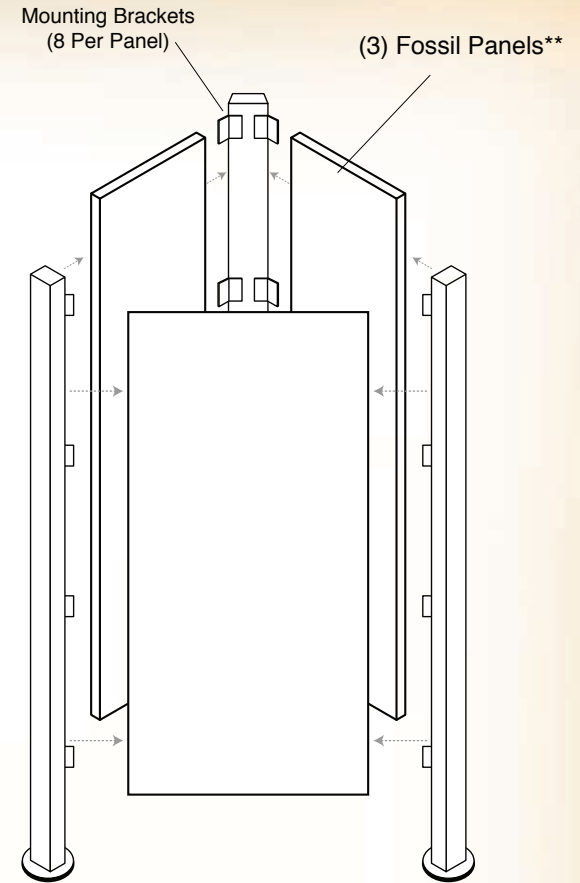

Multiple Post Assembly

## TRIANGULAR KIOSK-86 SPECIFICATIONS

Part #: KIOSK-86

\*\* Custom sizes available upon request

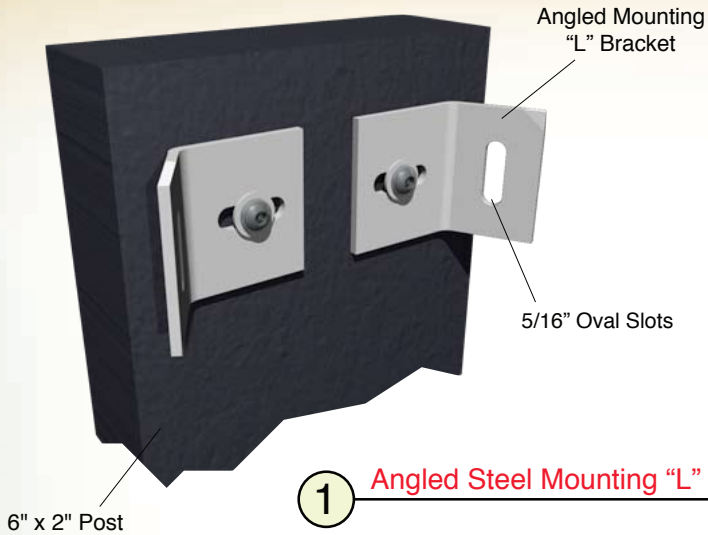

**1** Angled Steel Mounting "L" Shaped Bracket

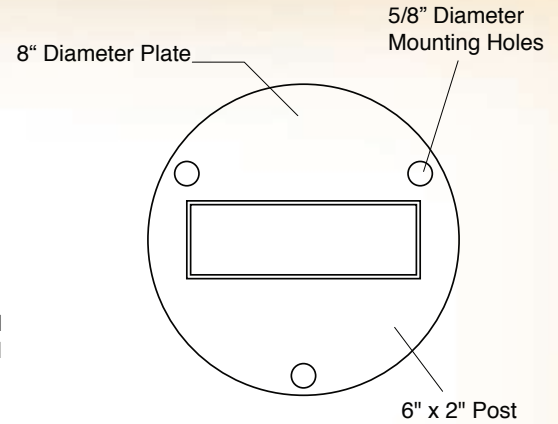
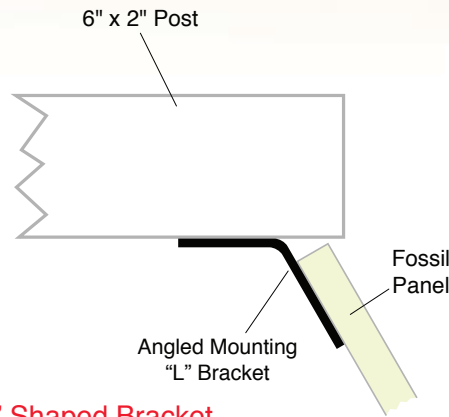

**2** 8" Diameter Base Plate (6x2 Post)

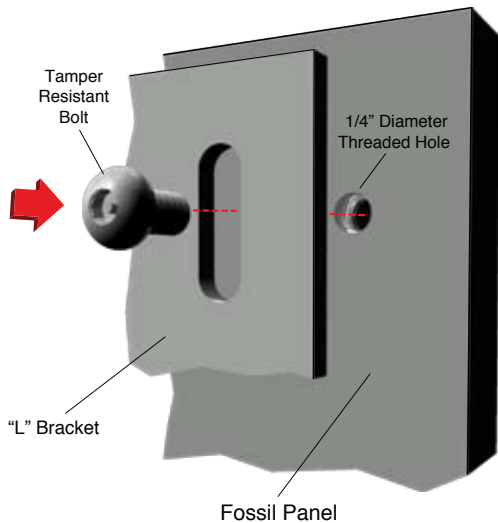

### 1/2" FOSSIL PANEL ON FOSSIL SUPPORT

TAMPER RESISTANT BOLT:

- BUTTON-HEAD ANTI-VANDAL SCREWS
- 1/2" LONG X 1/4" -20 THREAD
- STAINLESS STEEL

### 3/4" FOSSIL PANEL ON FOSSIL SUPPORT

TAMPER RESISTANT BOLT:

- BUTTON-HEAD ANTI-VANDAL SCREWS
- 5/8" LONG X 1/4" -20 THREAD
- STAINLESS STEEL

### 1" FOSSIL PANEL ON FOSSIL SUPPORT

TAMPER RESISTANT BOLT:

- BUTTON-HEAD ANTI-VANDAL SCREWS
- 3/4" LONG X 1/4" -20 THREAD
- STAINLESS STEEL

INCLUDES:

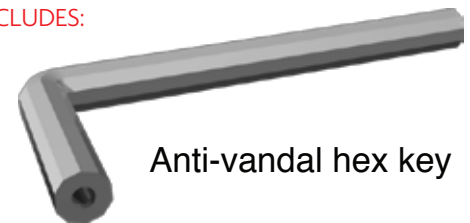

Anti-vandal hex key